

- high induction factor
- possible to be installed with an expansion box (SR/KWRD)
- nozzles are made of high-quality ABS material, and painted standard white
- all diffusers use nozzles of 35mm (RDM) and 57 mm (RD) diameter; single nozzle capacity of 6 and 9 m³ with acoustic pressure of 30 dB (A)
- diffusers of type R are additionally equipped with a decorative aluminium frame
- available in standard RAL 9003 colour
- upon customer's request, can be made available in any size and colour from RAL palette

INSTALLATION

KW/RD and KW/RDM diffusers are designed for installation with the expansion box SR/KWRD.

INSTALLATION IN THE FULL UNDERSLUNG CEILING:

prepare an installation hole in the ceiling of a size of the expansion box. Put the expansion box in so that edges stick out by approx. 12 mm from the ceiling panel. Fix it with steel screws. Remember to seal joints

INSTALLATION IN PANEL CEILING:

ventilator together with the expansion box should be installed above the ceiling level so that the front panel of the ventilator sticks evenly to the ceiling panel.

INSTALLING R-TYPE:

ventilator with the decorative frame can be fixed into the ceiling by appropriate bolts and screws through installation holes in the frame. Remember to seal joints.

DESCRIPTION

KW/RD are square ceiling with adjustable round nozzles designed for low- and medium-pressure installations. Nozzles of diameter sizes 57 (RD) and 35 (RDM) are ended with sinusoidal outlets that allows for high air diffusion. Nozzles position can be adjusted to any direction so that shape of the air stream can be regulated. They can be used with constant and variable airflow. The air can be supplied at the temperature lower or higher than the temperature in the ventilated room. It is recommended to install KW diffusers into the ceiling or hang them from the ceiling. diffusers available are square (K) or round (O).

FEATURES

- adjustable airflow stream shape (360°)
- easy dispersion of vertical stream
- possible to swirl the stream
- possible simultaneous vertical and horizontal ventilation

ORDER REFERENCE

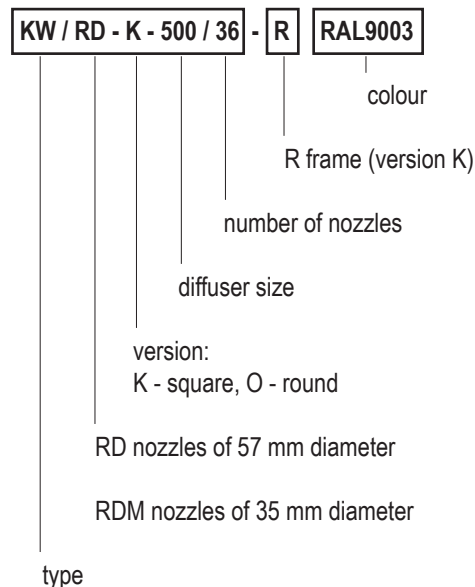

3.1 KW/RD, KW/RDM

square ceiling diffusers with adjustable nozzles

3

DIFFUSERS KW/RD-K

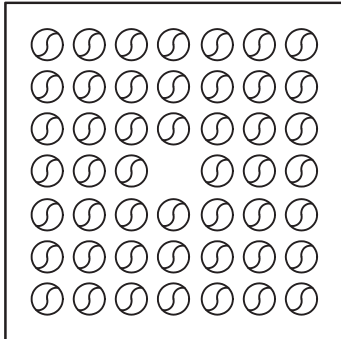

DIFFUSERS KW/RDM-K

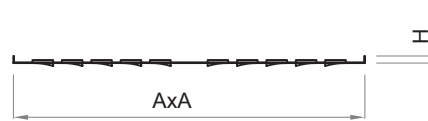
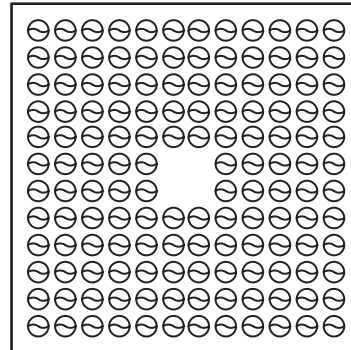

STANDARD SIZES

size	300	400	500	600
A [mm]	300	400	500	595
H [mm]	12	12	12	12
number of nozzles	16	25	36	48

STANDARD SIZES

size	300	400	500	600
A [mm]	300	400	500	595
H [mm]	12	12	12	12
number of nozzles	36	64	100	140

DIFFUSERS KW/RD-O

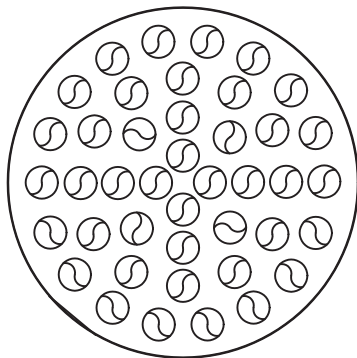

DIFFUSERS KW/RDM-O

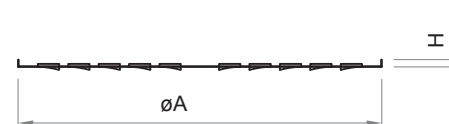
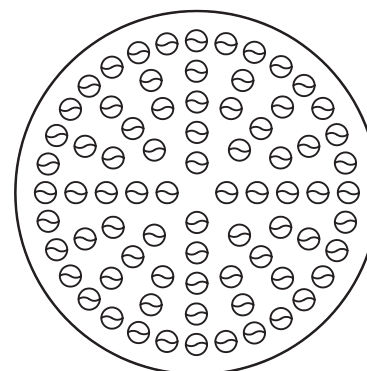

STANDARD SIZES

size	300	400	500	600
øA [mm]	300	400	500	600
H [mm]	12	12	12	12
number of nozzles	14	21	36	50

STANDARD SIZES

size	300	400	500	600
øA [mm]	300	400	500	600
H [mm]	12	12	12	12
number of nozzles	28	45	76	108

3.1.2

DIFFUSERS KW/RD-OK

round diffusers in square board (optional)

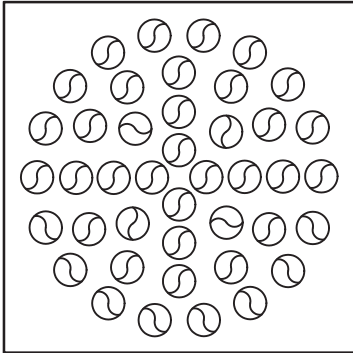

DIFFUSERS KW/RD-K

(optional)

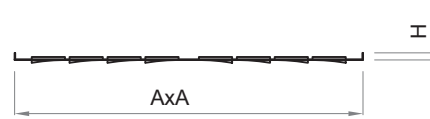
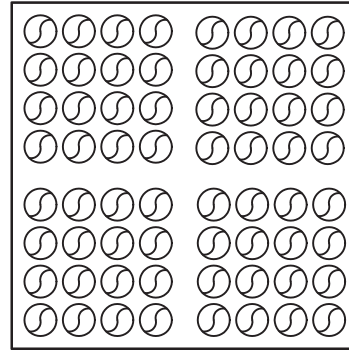

STANDARD SIZES

size	300	400	500	600
A [mm]	300	400	500	595
H [mm]	12	12	12	12
number of nozzles	14	21	36	50

STANDARD SIZES

size	600
A [mm]	595
H [mm]	12
number of nozzles	64

DIFFUSERS KW/RDM-OK

round diffusers in square board (optional)

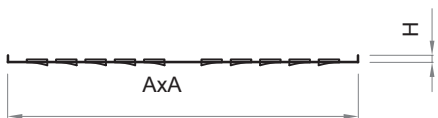
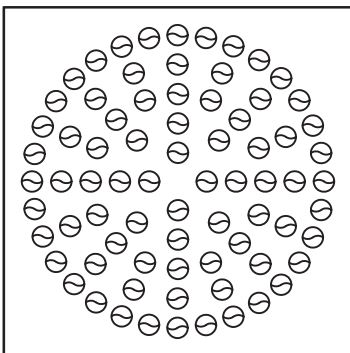

STANDARD

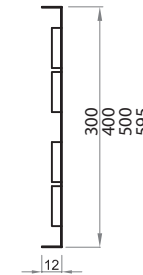

R- VERSION

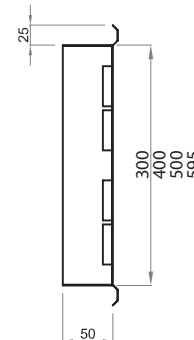

STANDARD SIZES

size	300	400	500	600
øA [mm]	300	400	500	595
H [mm]	12	12	12	12
number of nozzles	28	45	76	108

3.1 KW/RD, KW/RDM

square ceiling diffusers with adjustable nozzles

NUMBER OF LINES OF OUTFLOW OF AIR

	4	3	2	2	1
$b_n = l_{0,2} \times$	-	0,3	0,6	0,3	0,6
$L_{bn} = l_{0,2} \times$	-	0,8	0,8	0,8	1,0
$b_v = l_{0,2} \times$	0,05	0,05	0,05	0,05	0,05
$L_{bv} = l_{0,2} \times$	0,5	0,5	0,5	0,5	0,6

Dimensions stream (Isothermal flow)

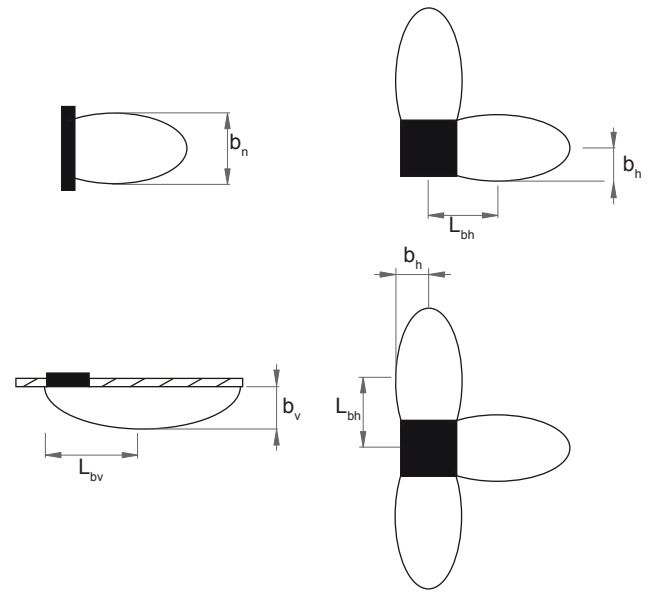

3

b_v = width vertical
 b_n = horizontal width

ARRANGEMENT OF NOZZLES

example arrangement of nozzles for different profiles of air outflow

4 way

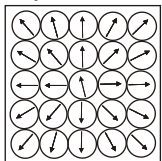

turmoil

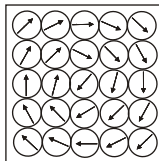

3 way

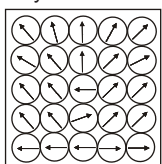

2 way
(opposite)

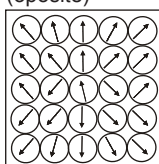

2 way
(corner)

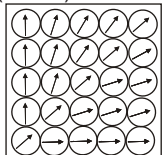

1 direction

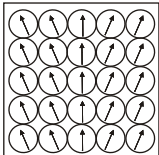

FLOW - PRESSURE DROP - SOUND LEVEL

Characteristics may not be used to regulate.

KW/RD-K

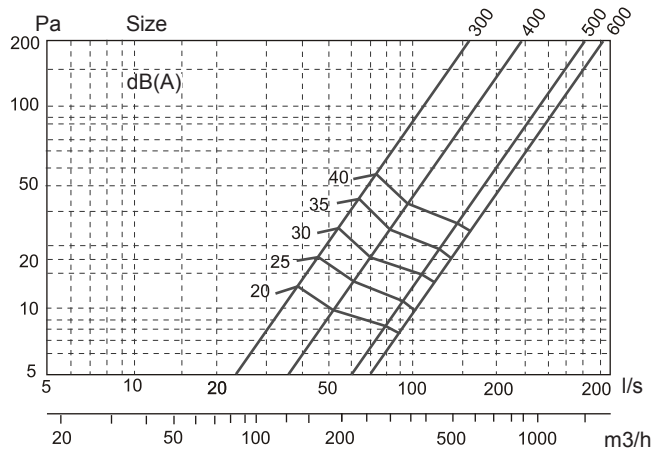

MOVEMENT - RANGE

4-WAY DISCHARGE

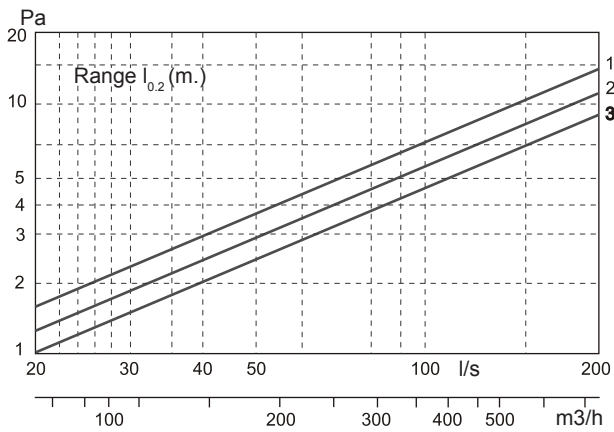

Size:

1. 300 2. 400 3. 600

Multiplier correction range

Number of lines of outflow:

3	2M	2H	1	turmoil
1.3	1.5	1.5	2.3	0.6

3.1 KW/RD, KW/RDM

square ceiling diffusers with adjustable nozzles

FLOW - PRESSURE DROP - SOUND LEVEL - RANGE

Characteristics may not be used to regulate

▽ = adjustable minimum flow

Coverage given to the outflow of the 4-way

3

KW/RD-K 300 + SR/KW/RD

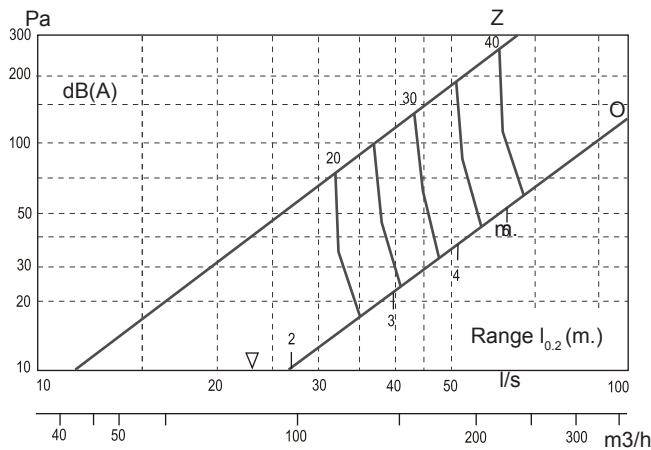

KW/RD-K 500 + SR/KW/RD

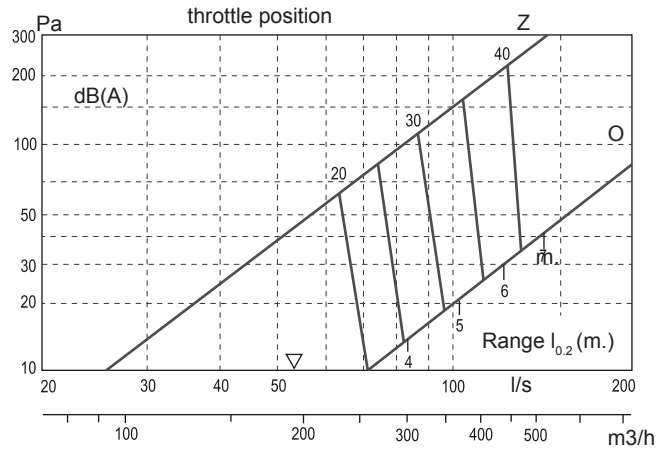

KW/RD-K 400 + SR/KW/RD

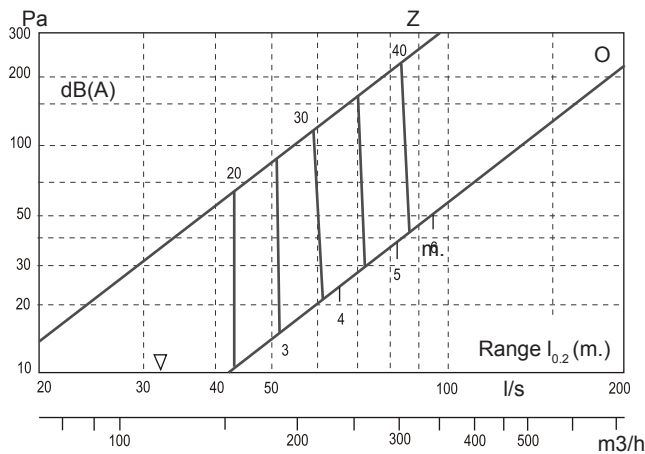

KW/RD-K 600 + SR/KW/RD

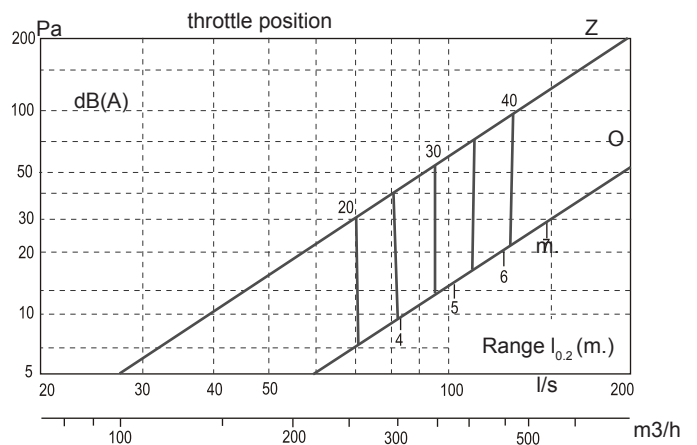

DIMENSIONS STREAM

(isothermal flow)

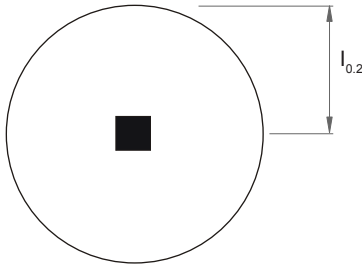

VARIANT DISTRIBUTION NOZZLES

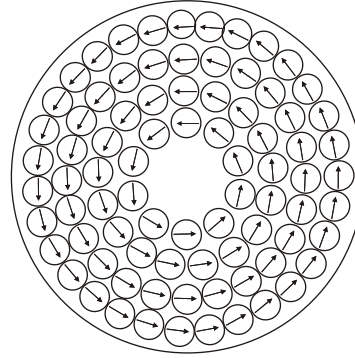

ACOUSTICAL DATA - KW-RDM

Sound power level L_w (dB)
Madman 1, 2 and 3 Closed slot side

Factor K_{OK}

Size	Center frequency band, Hz						
	125	250	500	1000	2000	4000	8000
300	5	2	1	1	-9	-29	-31
400	5	2	1	2	-12	-31	-31
500	6	4	3	-1	-14	-31	-29
600	5	3	3	0	-14	-33	-29
Tol. +/-	2	2	2	2	2	2	2

Sound insulation ΔL (dB)

Size	Center frequency band, Hz						
	125	250	500	1000	2000	4000	8000
300	14	9	4	3	5	5	4
400	14	8	3	3	4	5	5
500	11	5	4	2	3	4	4
600	9	4	2	2	2	3	3
Tol. +/-	2	2	2	2	2	2	2

ACOUSTICAL DATA - KW/RDM + SR/KW/RDM

Sound power level L_w (dB)

Factor K_{OK}

Size	Center frequency band, Hz						
	125	250	500	1000	2000	4000	8000
300	6	4	0	1	-11	-28	-28
400	6	5	0	1	-12	-29	-29
500	10	6	2	1	-12	-27	-25
600	8	4	2	0	-13	-31	-29
Tol. +/-	2	2	2	2	2	2	2

Sound insulation ΔL (dB)

Size	Center frequency band, Hz						
	125	250	500	1000	2000	4000	8000
300	14	10	17	19	12	10	12
400	11	10	17	19	12	10	12
500	8	8	16	17	12	12	13
600	6	7	19	14	10	10	13
Tol. +/-	2	2	2	2	2	2	2

3.1 KW/RD, KW/RDM

square ceiling diffusers with adjustable nozzles

Flow - Pressure drop - Sound level

Data refer to the diffuser without the box
Characteristics It may not be used to adjust.

KW/RDM-K

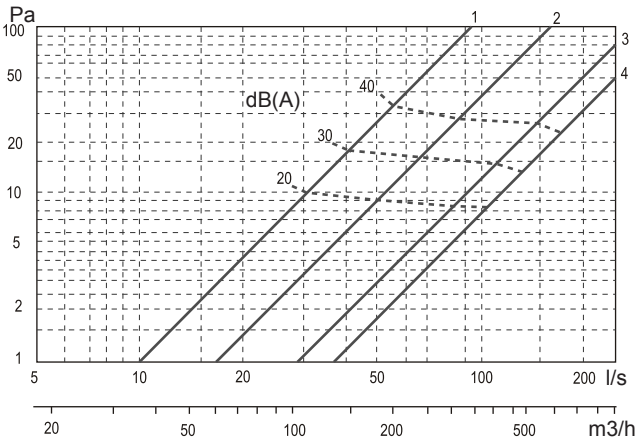

- 1. 300
- 2. 400
- 3. 500
- 4. 600

MOVEMENT - RANGE

TURBULENCE

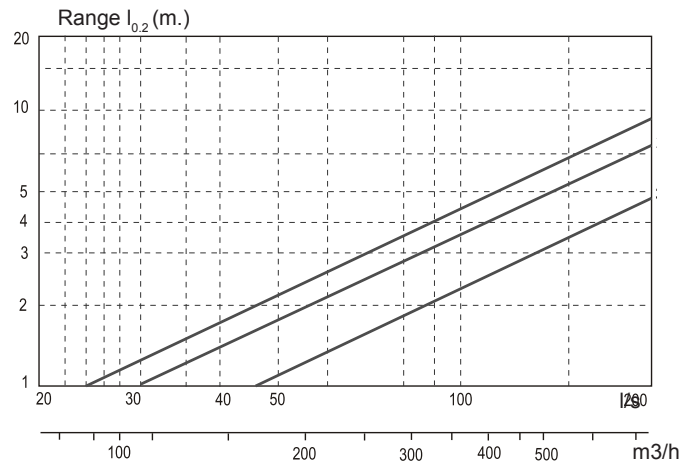

CHARACTERISTIC

Flow - Pressure drop - Sound level
Characteristics can not be used to adjust

KW/RDM-K 300 + SR/KW/RDM

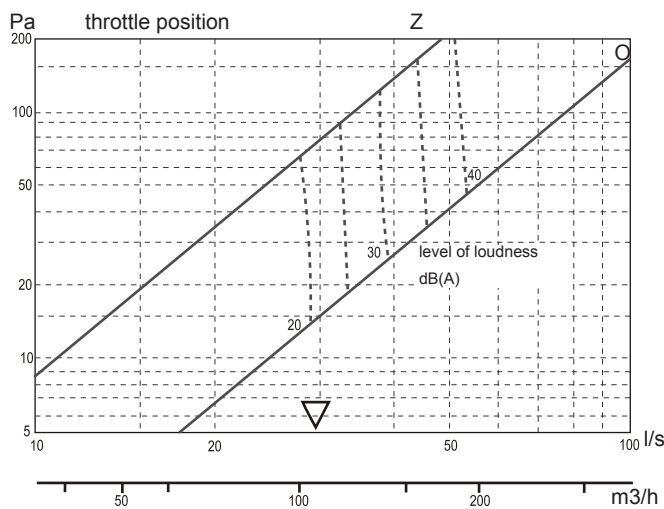

FLOW - PRESSURE DROP - SOUND LEVEL

Characteristics can not be used to adjust

KW/RDM-K 400 + SR/KW/RDM

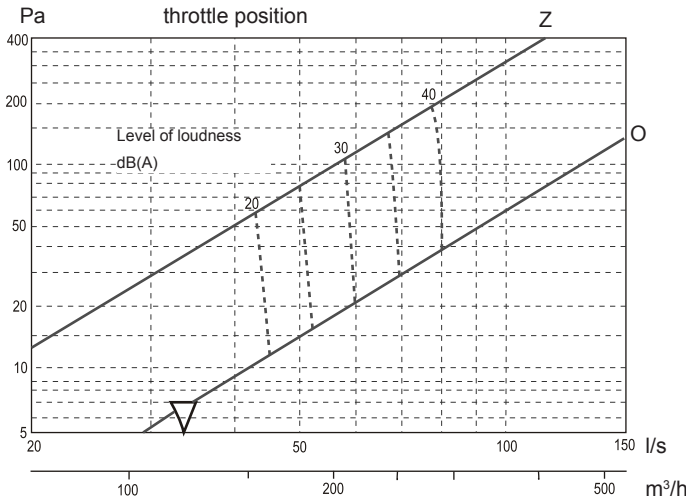

KW/RDM-K 500 + SR/KW/RDM

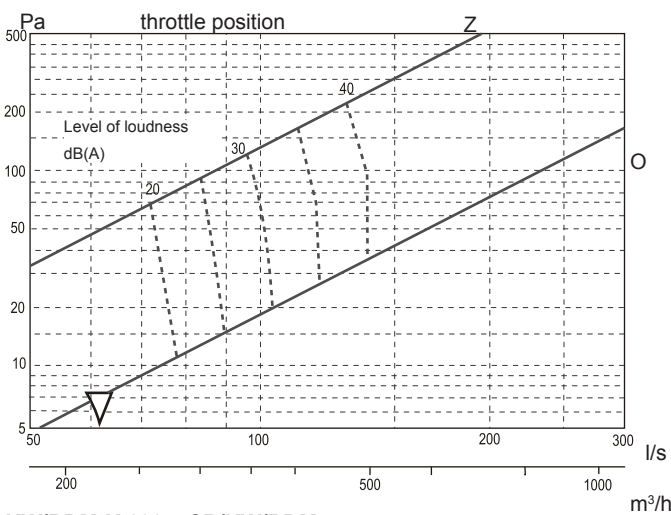

KW/RDM-K 600 + SR/KW/RDM

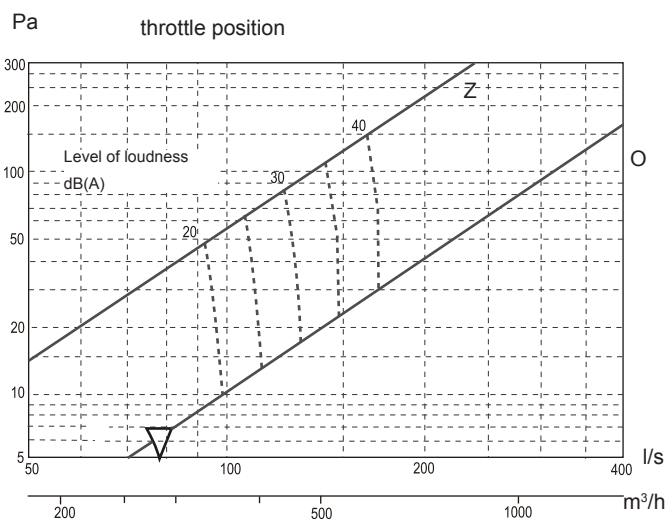

FLOW - PRESSURE DROP - SOUND LEVEL

Data refer to the diffuser KW / RDM-OK

Characteristics can not be used to adjust

KW/RDM-OK

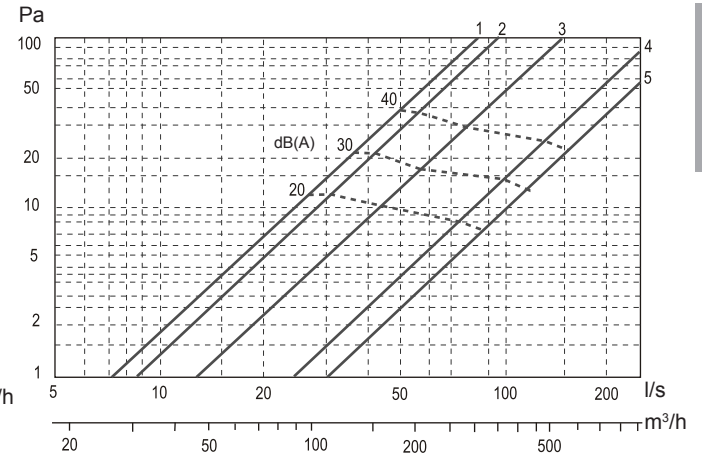

- 1. 300
- 2. 400
- 3. 500
- 4. 600

FLOW - RANGE

KW/RDM - OK, turmoil in accordance with (ZZ) and opposite (ZP)

KW/RDM-OK

Range $I_{0.2}$ (m)

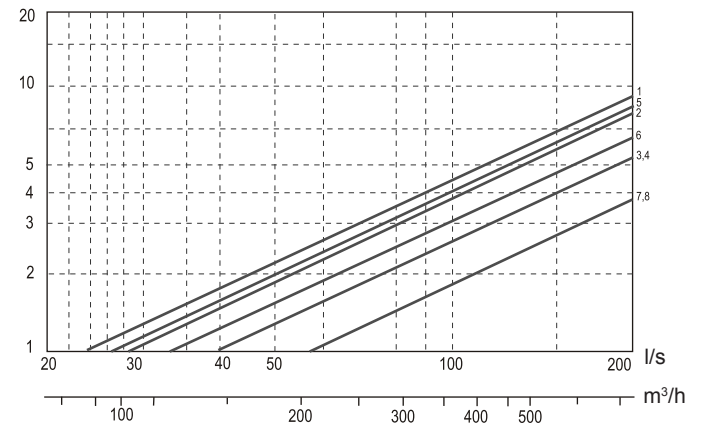

Turmoil in line

- 1. 160-300
- 2. 200-400
- 3. 250-600
- 4. 315-600

Against turmoil

- 5. 160-300
- 6. 200-400
- 7. 250-600
- 8. 315-600

3.1 KW/RD, KW/RDM

square ceiling diffusers with adjustable nozzles

FLOW - PRESSURE DROP - SOUND LEVEL - RANGE

Characteristics may not be used to regulate

KW/RDM-OK 300 + SR/KW/RDM

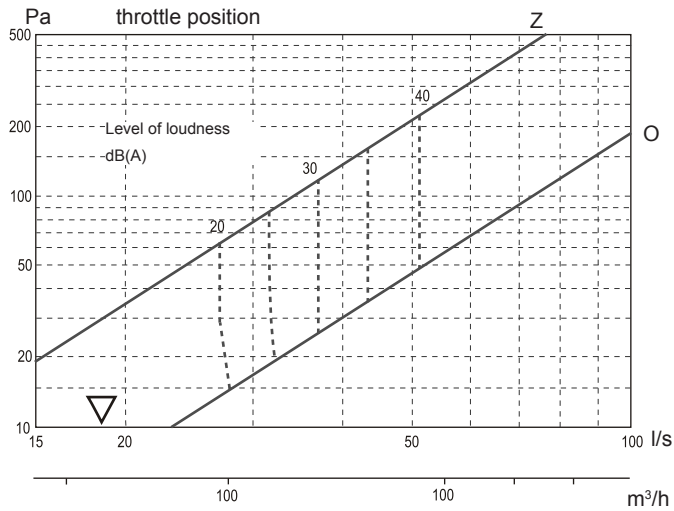

KW/RDM-OK 600 + SR/KW/RDM

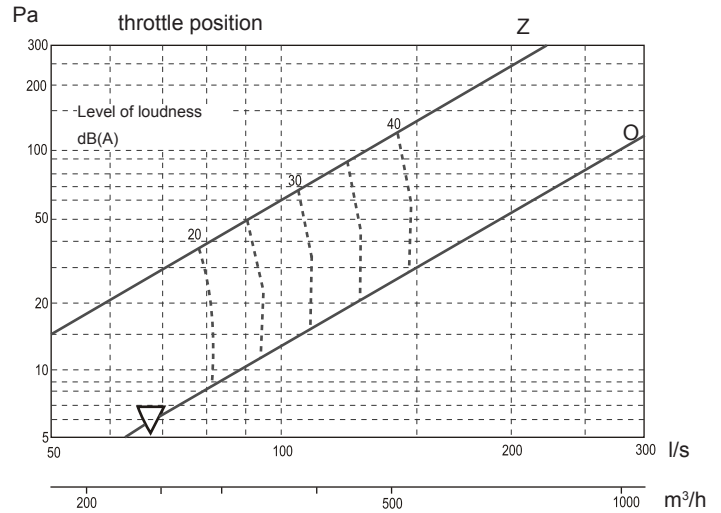

KW/RDM-OK 400 + SR/KW/RDM

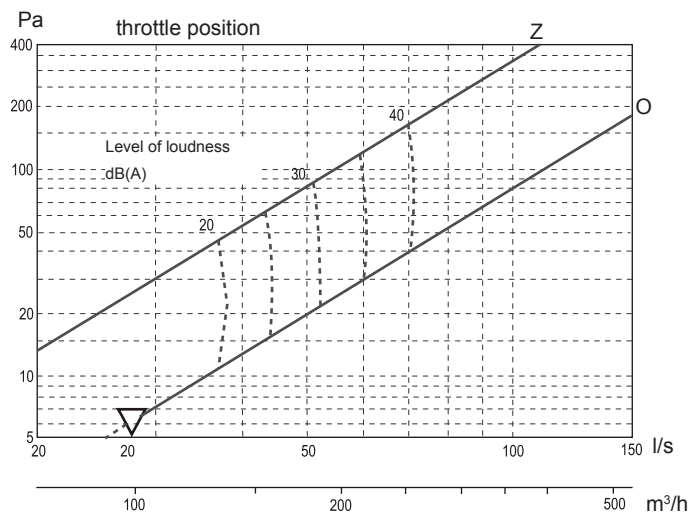

▽ = adjustable minimum flow
Coverage given to the outflow of the 4-way

KW/RDM-OK 500 + SR/KW/RDM

